

40 BT FLANGE

ADJUSTABLE "F" STYLE HYDRA-LOCK TOOL HOLDER

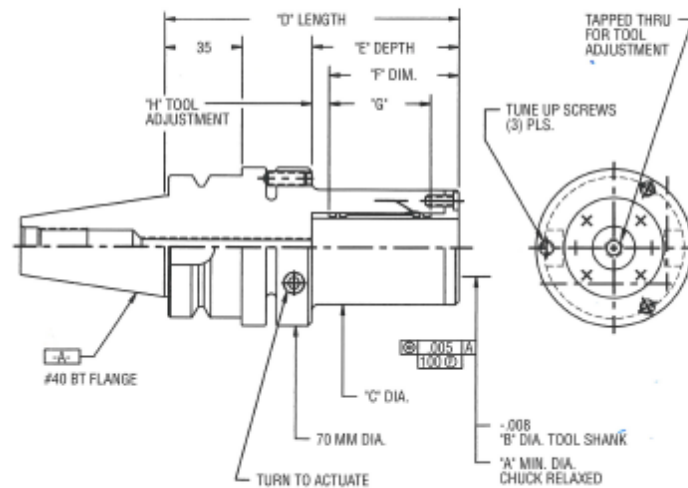

Hydra-Lock Tool No.	A DIA.	B DIA.	C DIA.	D LENGTH	E DEPTH	F LENGTH	G GRIP AREA	H LENGTH
40B0236F	6	5.995	33	114	48	41	28	6
40B0315F	8	7.995	33	114	48	41	28	6
40B0393F	10	9.995	35	114	48	41	28	6
40B0472F	12	11.995	38	121	54	48	35	6
40B0629F	16	15.995	41	121	54	48	35	6
40B0787F	20	19.995	45	133	67	59	46	8
40B0984F	25	24.995	51	133	67	59	46	8
40B1259F	32	31.995	57	133	67	59	46	8

The holders shown on this page represent some of the sizes available. If a size other than the "A" diameter is required or if a different "D" length is needed (for a longer extension or a shorter length), please ask us for a quotation.